

Presence detector
353-752321



4 year warranty

EN Presence detector P47LR, DALI-2, master, 32-37 m, 360°, for surface mounting
NL Aanwezigheidsmelder P47LR, DALI-2, master, 32-37 m, 360°, voor opbouw
FR Détecteur de présence P47LR, DALI-2, maître, 32-37 m, 360°, pour montage en saillie
DE Präsenzmelder P47LR, DALI-2, Master, 32-37 m, 360°, für Aufputz
DK Tilstedeværelsessensor P47LR, DALI-2, master, 32-37 m, 360°, påbygget
SE Närvarosensor P47LR, DALI-2, master, 32-37 m, 360°, för utarpåliggande montering
NO Tilstedeværelsessensor P47LR, DALI-2, master, 32-37 m, 360°, til utenpåliggende montering
IT Rilevatore di presenza P47LR, DALI-2, master, 32-37 m, 360°, per montaggio a parete
PL Czujnik obecności P47LR, DALI-2, nadrzędny, 32-37 m, 360°, do montażu natynkowego
SK Detektor prítomnosti P47LR, DALI-2, master, 32-37 m, 360°, na povrchovú montáž

Installation ⚠ 230 V – OFF

Instalatie / Installation / Installation / Installation / Installation / Installasjon / Installazione / Instalacja / Instalácia

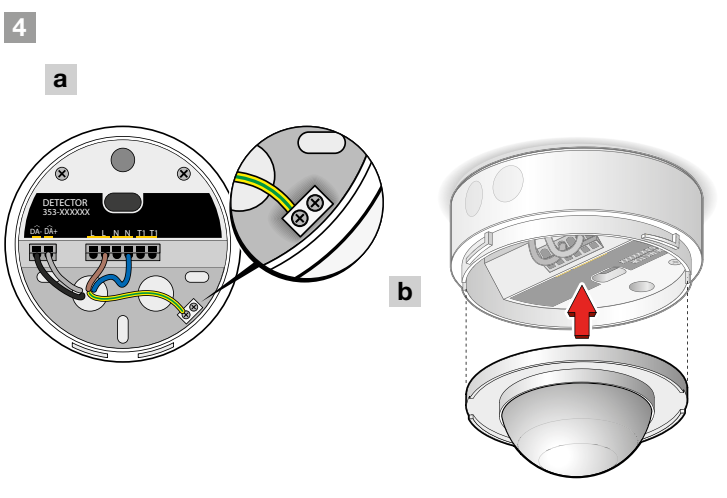
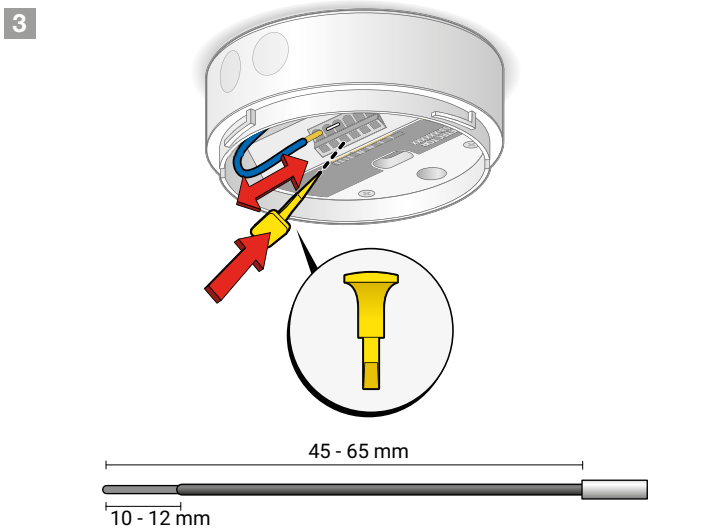
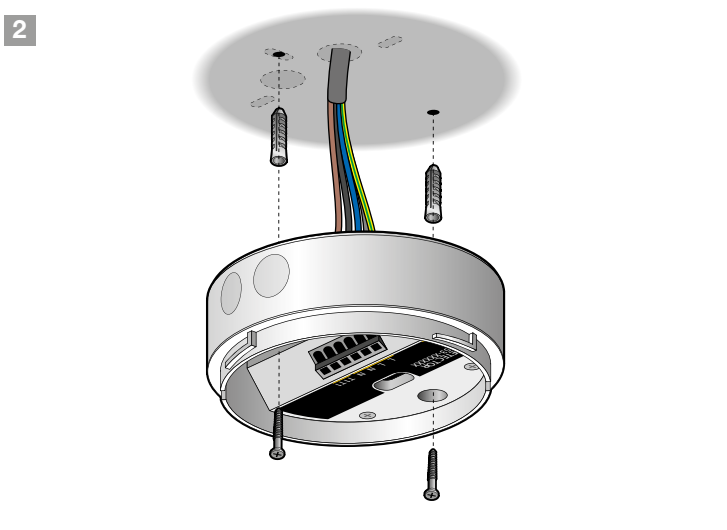
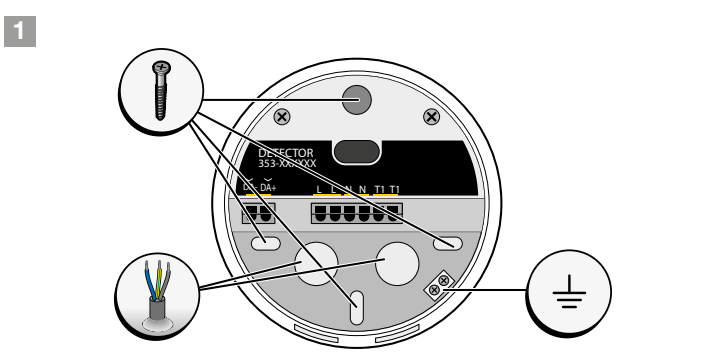

Wiring ⚠ 230 V – OFF

Aansluitschema / Schéma de raccordement / Verdrahtung / Tíslutningsskema / Kopplingschema / Ledningstilkopling / Cablaggio / Okablowanie / Instalácia

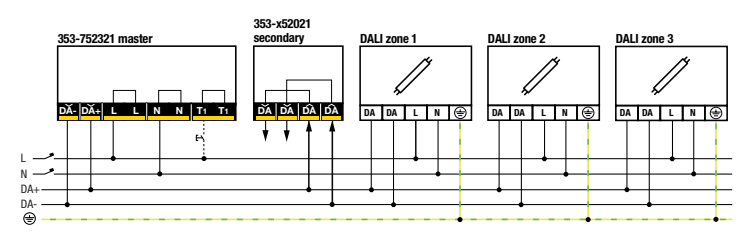

⚠ This product must be secured with a miniature circuit breaker (MCB) of max. 16 A in the electrical cabinet. The MCB rating is limited by national installation rules.

Dimensions

Afmetingen / Dimensions / Abmessungen / Dimensioner / Mått / Dimensjoner / Dimensioni / Wymiary / Rozmery

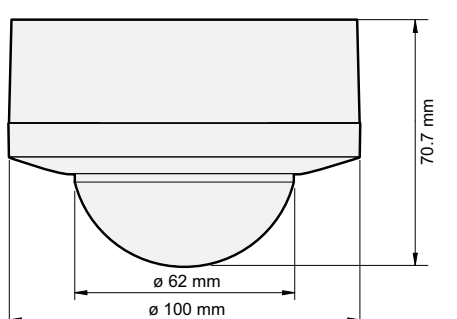

5

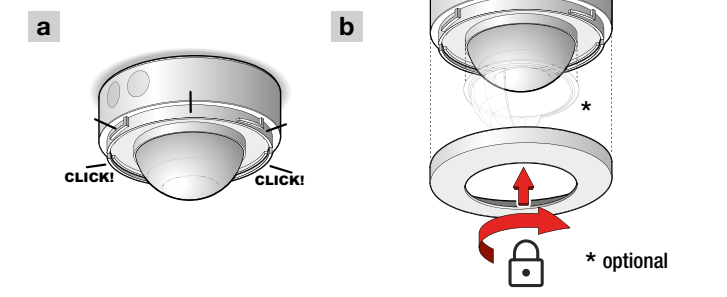

EN If a grommet needs to be replaced, please make sure the new grommet is halogen-free.
NL Indien de dichtingsring vervangen moet worden, kies dan voor een nieuwe, halogeenvrije dichtingsring.
FR Si un passe-câble doit être remplacé, veillez à ce que le nouveau passe-câble soit exempt d'halogène.
DE Wenn eine Durchführungsichtung ausgetauscht werden muss, stellen Sie bitte sicher, dass die neue Durchführungsichtung halogenfrei ist.
DK Hvis en membran skal udskiftes, er det vigtigt, at den nye er halogenfri.
SE Om en tätningssring måste bytas ut ska du kontrollera att den nya tätningssringen är halogenfri.
NO Sørg for at den nye pakningen er uten halogen dersom ringpakningen må byttes ut.
IT In caso di sostituzione di un occhio, assicurarsi che il nuovo occhio sia privo di alogeni.
PL Jeśli konieczna jest wymiana przelotki, należy upewnić się, że nowa przelotka nie zawiera halogenów.
SK Ak je potrebné vymeniť priechodku, uistite sa, že nová priechodka je bez halogénov.

Dismantling ⚠ 230 V – OFF

Demontage / Démontage / Demontage / Demontering / Demontera / Demontering / Smontaggio / Odmontowanie / Demontáž

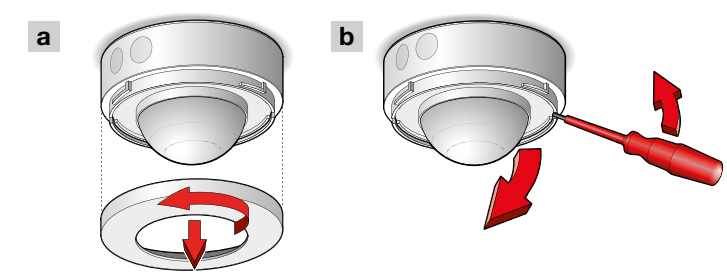

App settings ⚠ 230 V – ON

App-instellingen / Réglages de l'appli / App-Einstellungen / App inställinger / Appställningar / App-innställinger / Impostazioni dell'app / Ustawienia aplikacji / Nastavenia aplikácie

Factory settings			
	Switch ON/OFF	500 lux	15 min



LED behaviour ⚠ 230 V – ON

Ledgedrag / Comportement des LED / LED-Verhalten / LED funktioner / LED-funktioner / LED-funksjon / Comportamento del LED / Zachowanie LED / LED signalizácia

EN	Green LED continuous on		Connection OK	
	Green LED breathing		Connection OK, overrule ON	
	Green LED flashing		Warming up	Wait
	Red LED continuous on		Error	More info -->
	Red LED breathing		Warning	
	Blue LED flashing		Walk test active	

NL

Groene led brandt		Verbinding OK	
Groene led gaat langzaam aan en uit		Verbinding OK, overrulen AAN	
Groene led knippert		Warmt op	Even geduld
Rode led brandt		Fout	Meer informatie -->
Rode led gaat langzaam aan en uit		Waarschuwing	
Blauwe led knippert		Wandtest geactiveerd	

FR

LED verte allumée en continu		Connexion OK	
LED verte respire		Connexion OK, overrule ON	
LED verte clignote		Chauffe	Attendez
LED rouge allumée en continu		Erreur	Plus d'info -->
LED rouge respire		Avertissement	
LED bleue clignote		Test de mouvement actif	

DE

Grüne LED leuchtet		Verbindung OK	
Grüne LED pulsiert		Verbindung OK, überstimmen AN	
Grüne LED blinkt		Aufwärmen	Warten
Rote LED leuchtet		Fehler	Mehr Info -->
Rote LED pulsiert		Warnung	
Blau LED blinkt		Bewegungstest aktiv	

DK

Grøn LED lyser konstant		Forbindelse OK	
Grøn LED blinker langsomt		Forbindelse OK, overstyring aktiv	
Grøn LED blinker hurtigt		Varmer op	Vent
Rød LED lyser konstant		Fejl	Mere info -->
Rød LED blinker langsomt		Advarsel	
Blå LED blinker hurtigt		Gå-test aktiv	

SE

Grön LED kontinuerligt på		Anslutning OK	
Grön LED-andning		Anslutning OK, upphäva ON	
Grön LED blinkar		Värmer upp	Vänta
Röd LED kontinuerligt på		Fel	Mer information -->
Röd LED-andning		Varning	
Blå LED blinkar		Promenadtest aktivt	

NO

Grønn lysdiode kontinuerlig på		Tilkopling OK	
Grønn lysdiode fungerer		Tilkopling OK, overstyring PÅ	
Grønn lysdiode blinker		Varmes opp	Vent
Rød lysdiode kontinuerlig på		Feil	Mer info -->
Rød lysdiode fungerer		Advarsel	
Blå lysdiode blinker		Funksjonstest virksom	

LED verde sempre acceso	●	<i>Connessione OK</i>	
LED verde della respirazione	●	<i>Connessione OK, annullamento ACCESO</i>	
LED verde lampeggiante	●	<i>Riscaldamento</i>	<i>Attendere</i>
LED rosso sempre acceso	●	<i>Errore</i>	<i>Maggiori info --></i>
LED rosso della respirazione	●	<i>Avvertenza</i>	 niko detector tool
LED blu lampeggiante	●	<i>Test del cammino attivo</i>	

Zielona dioda LED świeci światłem ciągłym	●	<i>Połączenie OK</i>	
Zielone światło LED pulsuje	●	<i>Połączenie OK, odrzucić ON</i>	
Zielona dioda LED miga	●	<i>Rozgrzewanie</i>	<i>Czekaj</i>
Czerwona dioda LED świeci światłem ciągłym	●	<i>Błąd</i>	<i>Więcej informacji --></i>
Czerwona dioda LED pulsuje	●	<i>Ostrzeżenie</i>	 niko detector tool
Niebieska dioda LED miga	●	<i>Test przejścia aktywny</i>	

Zelená LED kontrolka svieti	●	<i>Pripojenie OK</i>	
Zelená LED pulzuje	●	<i>Pripojenie OK, ovládanie zapnuté</i>	
Zelená LED kontrolka blíká	●	<i>Zahrievanie</i>	<i>Počkajte</i>
Červená LED svieti	●	<i>Chyba</i>	<i>Viac informácií --></i>
Červená LED pulzuje	●	<i>Upozornenie</i>	 niko detector tool
Modrá LED blíká	●	<i>Test chodenia je aktívny</i>	

Specifications

Specificaties / Specifications / Spezifikationen / Specifikationer / Specifikationer / Spesifikasjoner / Specifiche / Specyfikacje / Technické údaje

Article number	353-752321
Configuration	DALI-2 master
Input voltage	230 Vac ± 10 %, 50 Hz
Maximum power consumption	0.5 W
Circuit breaker	maximum MCB rating 16 A*
Short circuit behaviour shutdown trigger	voltage below 12 V, exceeding 1.3 s
Short circuit behaviour restart period	every 14 s until success
Detector output	DALI Broadcast/DALI Adressable
Maximum voltage on the DALI bus	15 Vdc
Maximum supply current	250 mA
Maximum guaranteed current on DALI bus	100 mA
Maximum startup time DALI	< 1200 ms
Maximum PIR detection startup time	70 s
Maximum number of control gear on the DALI bus	64
Maximum number of dimmable zones	3
Light intensity range	20 – 2000 lux, ∞
Switch-off delay	pulse, 20 s – 120 min, ∞
Detection angle	360 °
Detection range (PIR)	ø 37 m from a height of 3 m
Ambient temperature	-25 – +40 °C
Mounting method	surface mounting
Mounting height	2 - 3,5 m
Colour	white (RAL 9010)
Dimensions visible (HxWxD)	100 x 100 x 70.7 mm
Dimensions (HxWxD)	100 x 100 x 70.7 mm
Wire capacity	1.5/2.5 mm²
Maximum range Bluetooth® (free field, depending on the device)	50 m
Operating frequency	2.4 GHz
Maximum radio frequency power	-2 dBm
Protection degree	IP54
Impact resistance	IK04
Modification of settings	app (iOS/Android) and 2-way Bluetooth® communication
Halogen-free	yes
Marking	CE

** The MCB rating is limited by national installation rules.*

Detection area

Detectieberek / Portée de détection / Erfassungsbereich / Rækkevidde / Detekteringsområde / Overvåkningsområde / Campo di rilevamento / Obszar wykrywania / Oblast snímania

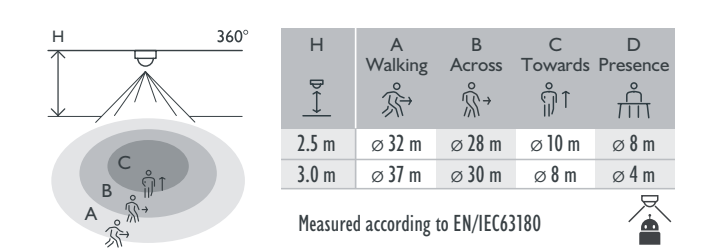

Troubleshooting

Probleemoplossing / Résolution des problèmes / Fehlerbehebung / Fejlfinding / Felsökning / Fellsøking / Risoluzione dei problemi / Rozwiązywanie problemów / Pomoc a podpora

EN		
<i>Problem</i>	<i>Possible cause</i>	<i>Proposed solution</i>
Load does not turn on	The wiring is not correct	Check the wiring scheme
	The ambient light is too strong	Check the response value luminosity and raise the value if necessary
Load does not turn off	The switch-off delay is too long	Check the switch-off delay and shorten the delay if necessary
	The detector receives false triggers	Check for any objects that may cause false triggering and remove them from the detection range or lower the sensitivity
App cannot connect to the detector	Bluetooth® has been disabled on your mobile device	Enable Bluetooth® on your mobile device

NL

<i>Probleem</i>	<i>Mogelijke oorzaak</i>	<i>Voorgestelde oplossing</i>
De belasting schakelt niet in	De bedrading is niet correct aangesloten	Raadpleeg het aansluitschema
	Het omgevingslicht is te fel	Controleer de ingestelde inschakeldrempel voor de lichtsterkte en verhoog deze indien nodig
De belasting schakelt niet uit	De uitschakelvertraging is te lang	Controleer de ingestelde uitschakelvertraging en verkort deze indien nodig
	De detector ontvangt valse triggers	Controleer of er in het detectiegebied objecten aanwezig zijn die valse triggers kunnen veroorzaken en verwijder deze of verlaag de gevoeligheid
De app kan geen verbinding maken met de detector	Bluetooth® is gedeactiveerd op je mobiel toestel	Activeer Bluetooth® op je mobiel toestel

FR

<i>Problème</i>	<i>Cause possible</i>	<i>Solution proposée</i>
La charge ne s'active pas	Le câblage n'est pas raccordé correctement.	Consultez le schéma de raccordement
	La luminosité est trop vive	Vérifiez le seuil d'activation défini pour l'intensité lumineuse et augmentez-le si nécessaire
La charge ne se désactive pas	La temporisation de déconnexion est trop longue	Vérifiez la temporisation de déconnexion définie et raccourcissez-la si nécessaire
	Le détecteur reçoit de faux déclenchements	Vérifiez si des objets pouvant causer de faux déclenchements sont présents dans la zone de détection et éliminez-les ou diminuez la sensibilité
L'appli ne trouve pas le détecteur	Bluetooth® désactivé sur votre smartphone	Activez Bluetooth® sur votre smartphone

DE

<i>Problem</i>	<i>Mögliche Ursache</i>	<i>Lösungsvorschlag</i>
Das Licht schaltet sich nicht ein	Der Verdrahtung wurde nicht richtig angeschlossen	Richten Sie sich nach dem Anschlussplan

	Das Umgebungslicht ist zu hell	Kontrollieren Sie die eingestellte Ansprech-helligkeit und erhöhen Sie diese nötigenfalls
Das Licht schaltet sich nicht aus	Die Ausschaltverzögerung ist zu lang	Kontrollieren Sie die eingestellte Ausschaltverzögerung und reduzieren Sie diese nötigenfalls

	Der Detektor empfängt falsche Signale	Kontrollieren Sie, ob sich Gegenstände im Erfassungsbereich befinden, die die Ursache für falsche Signale sein können und entfernen Sie diese oder senken Sie die Empfindlichkeit des Melders
--	---------------------------------------	---

Die App kann keine Verbindung herstellen	Bluetooth® ist auf Ihrem mobilen Gerät deaktiviert	Aktivieren Sie Bluetooth® auf Ihrem mobilen Gerät
---	--	---

DK

<i>Problem</i>	<i>Mulig årsag</i>	<i>Løsningsforslag</i>
Belastning tænder ikke	Fortrådning er ikke korrekt	Check tilslutningsskema
	Det omgivende lysniveau er for højt	Kontroller luxindstillingen og hæv værdien, hvis det er nødvendigt
Belastning slukker ikke	Tidsforsinkelsen er for lang	Kontroller tidsindstillingen og forkort forsinkelsen, hvis det er nødvendigt
	Sensoren fejltændinger	Kontroller for genstande, der kan forårsage fejltænding og fjern dem fra detekteringsområdet eller minimerede følsomheden

App kan ikke få forbindelse til sensoren	Bluetooth® er blevet deaktiveret på din mobile enhed	Aktiver Bluetooth® på din mobile enhed
---	--	--

SE

<i>Problem</i>	<i>Möjlig orsak</i>	<i>Föreslagen lösning</i>
Belastningen slås inte på	Ledningsdragningen är inte korrekt	Kontrollera kopplings schemat
	Det omgivande ljuset är alltför starkt	Markera luxintervall och höj värdet vid behov
Belastningen stängs inte av	Avstängningsfördröjningen är för lång	Kontrollera avstängningsfördröjningen och minska tiden vid behov
	Detektorn tar emot falsklarm	Kontrollera om något objekt kan utlösa falsklarm och ta bort dem från detektionssområdet eller sänk känsligheten
Appen kan inte ansluta till detektorn	Bluetooth® har inaktiverats på din mobila enhet	Aktivera Bluetooth® på din mobila enhet

NO

<i>Problem</i>	<i>Mulig årsak</i>	<i>Løsningsforslag</i>
Strømforsyningen koples ikke på	Ledningstilkoplingen er ikke riktig utført	Sjekk koplings skjemaet
	Rombelysningen er for sterk	Sjekk lux innstilling, og om nødvendig sett opp verdiene
Strømforsyningen koples ikke ut	Forsinket utkopling tar for lang tid	Kontroller forsinket utkopling, og reduser forsinkelsen om nødvendig
	Sensoren mottar falske triggerere	Kontroller alle gjenstander som kan forårsake falske triggerere, og fjern dem fra overvåkningsområdet eller reduser følsomhet

App kan ikke tilkoples sensoren	Bluetooth® har blitt deaktivert på mobilenheten din	Aktiver Bluetooth® på mobilenheten din
--	---	--

IT

<i>Problema</i>	<i>Possibile causa</i>	<i>Soluzione proposta</i>
Il carico non si accende	Il collegamento elettrico è errato	Controllare lo schema elettrico
	La luce ambiente è troppo forte	Controllare la luminosità del valore di risposta ed eventualmente aumentarla
Il carico non si spegne	Il ritardo di spegnimento è troppo lungo	Controllare il ritardo di spegnimento ed eventualmente accorciarlo
	Il rivelatore riceve inneschi errati	Verificare la presenza di oggetti che potrebbero innescare attivazioni errate e rimuoverli dal campo di rilevamento o abbassare la sensibilità.
La app non riesce a connettersi al rivelatore	Il Bluetooth® è stato disabilitato sul dispositivo mobile	Abilitare il Bluetooth® sul dispositivo mobile

PL

<i>Problem</i>	<i>Możliwa przyczyna</i>	<i>Proponowane rozwiązanie</i>
Obciążenie nie włącza się.	Okablowanie nie jest prawidłowe.	Sprawdź schemat okablowania.
	Światło otoczenia jest zbyt silne.	Sprawdź wartość reakcji jasności i w razie potrzeby zwiększ wartość.
Obciążenie się nie wyłącza	Opóźnienie wyłączenia trwa zbyt długo.	Sprawdź opóźnienie wyłączenia i w razie potrzeby skróć opóźnienie
	Detektor otrzymuje fałszywe wyzwalacze.	Sprawdź, czy jakiegokolwiek objekty nie powodują fałszywego wyzwalania i usuń je z zakresu wykrywania lub zmniejsz czułość.
Aplikacja nie może połączyć się z wykrywaczem.	Bluetooth® został wyłączony w urządzeniu mobilnym.	Włącz Bluetooth® na urządzeniu mobilnym.

SK

<i>Problém</i>	<i>Možná príčina</i>	<i>Navrhované riešenie</i>
Svetlo sa nezapne	Detektor nie je správne zapojený	Skontrolujte schému zapojenia
	Oneskorenie vypnutia je príliš dlhé	Skontrolujte nastavenie citlivosti detektora a ak je to potrebné tak zvýšte citlivosť
Svetlo sa nevypne	Oneskorenie vypnutia je príliš dlhé	Skontrolujte oneskorenie a ak je to potrebné, tak ho skráťte
	Detektor prijíma falošné spúšťače	Skontrolujte akékoľvek objekty, ktoré môžu spôsobovať falošné spustenie a odstráňte ich z detegovanej oblasti, alebo znížte citlivosť
Aplikácia sa nevie pripojiť k detektoru	Na vašom mobilnom zariadení je vypnutý Bluetooth®	Zapnite Bluetooth® na vašom mobilnom zariadení

Support & contact

nv Niko sa
Industriepark West 40
9100 Sint-Niklaas, Belgium

EN	+32 3 778 90 80	support@niko.eu
NL	België: +32 3 778 90 80 <p>Nederland: +31 880 15 96 10</p>	support.be@niko.eu <p>support.nl@niko.eu</p>
FR	Belgique: +32 3 778 90 80 <p>France: +33 820 20 66 25</p> <p>Suisse: +41 44 878 22 22</p>	support.be@niko.eu <p>support.fr@niko.eu</p> <p>support.ch@niko.eu</p>
DE	Deutschland: +49 7623 96697-0 <p>Schweiz: +41 44 878 22 22</p> <p>Österreich: +43 1 7965514</p> <p>Belgien: +32 3 778 90 80</p>	support.de@niko.eu <p>support.ch@niko.eu</p> <p>support.at@niko.eu</p> <p>support.be@niko.eu</p>
DK	+45 74 42 47 26	support.dk@niko.eu
SE	+46 8 410 200 15	support.se@niko.eu
NO	+47 66 77 57 50	support.no@niko.eu
IT	+41 44 878 22 22	support.ch@niko.eu
PL	+48 509 378 373	support.pl@niko.eu
SK	+421 2 63 825 155	support.sk@niko.eu

Niko prepares its manuals with the greatest care and strives to make them as complete, correct and up to date as possible. Nevertheless, some deficiencies may subsist. Niko cannot be held responsible for this, other than within the legal limits. Please inform us of any deficiencies in the manuals by contacting Niko customer services at support@niko.eu.